

# GRADALL®

## XL 4200 III

### HYDRAULIC EXCAVATOR



## SPECIFICATIONS

### Upperstructure Engine

Detroit Diesel OM904 Tier-3 diesel, 4 cycle, inline 4 cylinder, liquid cooled, electronic controlled. Vertical canister style lube filter attached to engine. Remote mount primary fuel/water separator.

Gross Rating: 173HP @ 2200 RPM (129kW)  
498 ft. lb. Torque @ 1200-1600 RPM (675Nm)

Net Rating: 153 HP @ 2200 RPM (114kW)

Variable viscous fan clutch system. Vertical stacked hyd. oil cooler, charge air cooler and radiator

Maximum slope: 30°

12 volt starter, 100 amp alternator, two SAE #C31-S 1000 CCA batteries, two-stage dry type air cleaner with centrifugal precleaner and safety element. Evacuator valve and service indicator.

Fuel tank capacity: 99 gallons (375 L).

### Hydraulic System

#### PUMPS

One load-sensing, axial piston pump; oil flow 0-110 GPM (0-435 L/min).

Gear pump, pilot, 6GPM (23L/min)

#### SYSTEM MONITOR

Electronic monitor in cab indicates low hydraulic fluid level, high hydraulic fluid temperature, system working pressure, system pilot pressure.

#### SYSTEM SPECIFICATIONS

#### Four cylinders

- 1 tool: 5.0" ID, 3.0" rod (127 mm x 76 mm), 25.9" (658 mm) stroke.
- 2 hoist: 4.25" ID, 3.15" rod (108 mm x 80 mm), 31.0" (787 mm) stroke.
- 1 telescope: 3.5" ID, 2.559" rod (89 mm x 65 mm), 12'6" (3.81 m) stroke.

#### Four hydraulic motors

Swing, 64hp (48 kW); tilt, 21 hp (16 kW); 2 propel motors, 120 hp (89 kW) each.

#### Operating pressures:

Hoist.....	4,900 psi	(331 BAR)
Tilt .....	4,900 psi	(331 BAR)
Swing .....	4,200 psi	(290 BAR)
Tool.....	4,900 psi	(331 BAR)
Telescope .....	4,900 psi	(331 BAR)
Propel.....	4,900 psi	(331 BAR)
Pilot System .....	550 psi	(38 BAR)

#### Oil Capacity

Reservoir system 65 gallons (246 L). Pressurized reservoir with visual oil level gauges.

#### Filtration System

10 micron return filter, 10 micron pilot filter.

Fin and tube-type oil cooler with thermal by-pass and relief valves.

Pressure-compensated, load-sensing valves with circuit reliefs in all circuits.

### Operator Cab

All-weather cab with tinted safety glass windows, skylight, acoustical lining, four-way adjustable operator's seat, AM/FM radio, filtered fresh air heater, defroster, and A/C. Front window slides to overhead storage. Rearview mirrors on right and left sides. Standard equipment includes windshield wiper and washer, swing lights and work lights.

### Controls

Two electronic joysticks (hoist and bucket, telescope and swing), one rocker switch (tilt) control upperstructure. Joysticks mounted on arm pods, independently adjustable for individual operator comfort and convenience.

Quick change joystick pattern switch located on instrumental panel. Joysticks are self-centering; when controls are released, power for movement disengages and swing and tilt brake set automatically.

Two electric foot pedals (with handles) control crawler travel speed and direction, crawler steering, and crawler brakes. Toggle switch on arm pod allows selection of two crawler speed ranges.

#### Engine Controls and Instrumentation

Key operated ignition/starter switch, throttle, and main battery disconnect switch. air cleaner condition indicator. Electronic monitor indicates fuel level, low battery charge, lube oil pressure, high coolant temperature, engine rpm, and engine hours. Fuel saving auto idle feature sends engine rpm to idle when control circuits are in neutral for seven seconds.

### Swing

Priority swing circuit with axial piston motor. Planetary transmission.

Swing speed: 7.0 rpm.

#### Swing Brake

Automatic spring-set/hydraulic release wet disc parking brake. Dynamic braking is provided by the hydraulic system.

## Crawler Drive

Dual range, high torque piston motor powers each track. Three-stage planetary drive with integral speed limiting valve and automatic spring-set/hydraulic release wet disc parking brake.

**Travel Speed:** on flat, level surface:

High Speed: 3.4 mph (5.5 km/h)

Low Speed: 1.9 mph (3.1 km/h)

Automatic two-speed control shifts crawler drive into low speed under difficult travel conditions. Manual override switch for loading the machine for transport.

**Gradeability:**

58%, limited by engine lubrication requirements

## Drawbar Pull

38,324 lb (170 kN)

## Individual Track Control

Tracks counter-rotate to pivot machine about the swing centerline. Electronically operated travel alarm signals crawler movement in either direction.

## Function Forces

**Rated Boom Force:**

22,075 lb (98.2 kN)

**Rated Bucket Breakout Force:**

25,405 lb (113 kN)

## Weight

Approximate working weight with 36" (914mm) excavating bucket, fuel tank half full and no operator.

Pad Size	Weight	Bearing Pressure
31.5" 800mm	46,862 lb (21,256 kg)	5.7 psi (39.3 kPa)
23.6" 600mm	45,746 lb (20,750 kg)	7.3 psi (50.3 kPa)

## GRADALL Model XL 4200 III Lift Capacity - lb. (kg)

LOAD POINT HEIGHT		LOAD RADIUS										
		10' (3.0m)		15' (4.6m)		20' (6.1m)		25' (7.6m)		MAXIMUM RADIUS	OVER END	OVER SIDE
		OVER END	OVER SIDE	OVER END	OVER SIDE	OVER END	OVER SIDE	OVER END	OVER SIDE			
Above Ground Level	15' (4.6m)			9850 (4470)	9850 (4470)	6955 (3155)	6955 (3155)	5110 (2320)	5110 (2320)	25'6" (7.8m)	4965 (2250)	4965 (2250)
	10' (3.0m)			11800 (5350)	11800 (5350)	7910 (3590)	7910 (3590)	5655 (2565)	5655 (2565)	26'11" (8.2m)	5030 (2280)	5030 (2280)
	BOOMLEVEL 7'9" (2.6m)			12375 (5615)	12375 (5615)	8190 (3715)	8190 (3715)	5820 (2640)	5820 (2640)	27'2" (8.3m)	5080 (2305)	5080 (2305)
	5' (1.5m)			12590 (5710)	12590 (5710)	8345 (3785)	8345 (3785)	5930 (2690)	5930 (2690)	27'3" (8.3m)	5155 (2340)	5155
At Ground Level				11475 (5205)	11475 (5205)	8045 (3650)	8045 (3650)	5850 (2655)	5850 (2655)	26'8" (8.1m)	5310 (2410)	(2340) 5310
Below Ground Level	5' (1.5m)	10845 (4920)	10845 (4920)	9320 (4225)	9320 (4225)	7160 (3250)	7160 (3250)			24'11" (7.6m)	5475 (2485)	(2410)
	10' (3.0m)	7130 (3235)	7130 (3235)	7190 (3260)	7190 (3260)	6035 (2735)	6035 (2735)			21'10" (6.7m)	5580 (2530)	5475 (2485)
	15' (4.6m)	4745 (2150)	4745 (2150)	5445 (2470)	5445 (2470)					16'7" (5.1m)	5345 (2425)	5580 (2530)

The above loads are in compliance with the SAE standard J1097 DEC2005. They do not exceed 87% of hydraulic lifting capacity or 75% of tipping capacity.

Loads shown in shaded areas indicate the load is limited by tipping rather than hydraulic lift capacity.

The rated lift capacity is based on the machine being equipped with 8,850 lb (4014 kg) counterweight, standard boom, standard tires, no auxiliary hydraulics, and no bucket.

Adjust the listed rated capacities by subtracting the value listed for bucket/attachment used:

8065-6007 60" (1.5m)	Ditching -	807 lbs. (366kg)
8065-6006 66" (1.7m)	Ditching -	892 lbs. (405kg)
8065-6118 72" (1.6m)	Ditching -	1148 lbs. (521kg)
8045-6020 24" (610mm)	Excavating -	603 lbs. (274kg)
8045-6021 30" (762mm)	Excavating -	660 lbs.
8045-6022 36" (914mm)	Excavating -	741 lbs.
8045-6023 42" (1.1m)	Excavating -	841 lbs.
8065-6117 48" (1.5m)	Excavating -	959 lbs.
8065-6013 72" (1.8m)	Dredging -	1114 lbs.
8065-6102 40" (1.0m)	Pavement -	1262 lbs.
8065-6024 8' (2.4m)	Blade -	630 lbs.
8065-6009	Single Tooth Ripper-	557 lbs.

• Note: Bucket adjustment values are 87% of the actual bucket weights.

The load point is located on the bucket pivot point, including loads listed for maximum radius.

Do not attempt to lift or hold any load greater than these rated values at specified load radii and heights. The weight of slings and any auxiliary devices must be deducted from the rated load to determine the net load that may be lifted.

ATTENTION: All rated loads are based on the machine being stationary and level on a firm supporting surface. The user must make allowance for particular job conditions such as soft or uneven ground, out of level conditions, experience of personnel, etc. The operator and other personnel must read understand the operator manual before operating this machine. Rules for safe operation of equipment must be adhered to at all times.

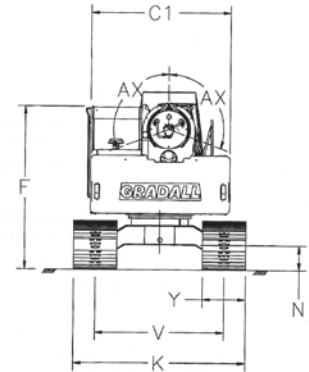
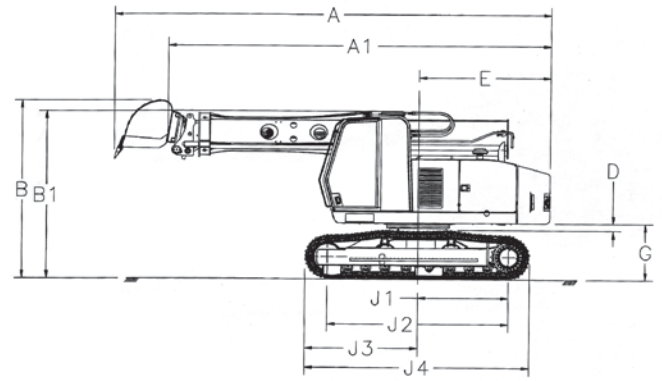
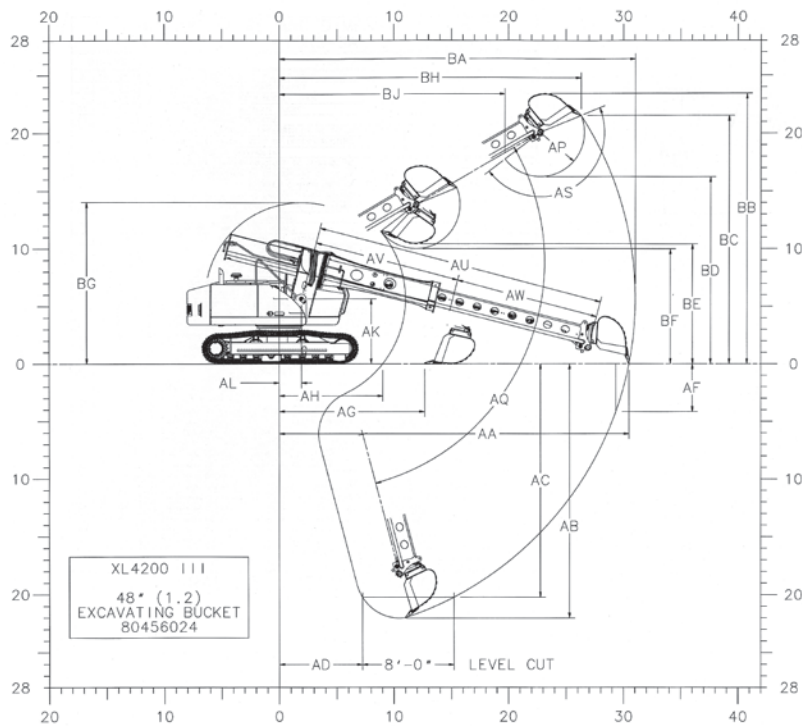

## Dimensions

- A** Overall length with bucket open: 26'6" (8.1)
- A1** Overall length without bucket: 23'3" (7.1)
- B** Overall height with bucket open: 10'9" (3.3)
- B1** Overall height without bucket: 10'1" (3.1)
- C1** Width of upperstructure: 8'6" (2.6)
- D** Minimum clearance, upperstructure to undercarriage: 5" (130mm)
- E** Swing clearance, rear of upperstructure: 8'0" (2.4)
- F** Top of cab to groundline: 9'10" (3.0)
- G** Clearance, upperstructure to groundline: 3'5" (1.0)
- J1** Axis of rotation to centerline of drive sprockets: 5'1" (1.7)
- J2** Nominal distance between centerlines of drive sprockets and idlers: 11'0" (3.4)
- J3** Axis of rotation to end of track assembly: 6'10" (2.1)
- J4** Nominal overall length of track assembly: 13'8" (4.2)
- K** Width of crawler (standard): 10'6" (3.2)  
Width of crawler (optional): 9'10" (3.0)
- N** Ground clearance (per SAE J1234): 18" (454 mm)
- V** Track gage, roller centerline to roller centerline: 7'10" (2.4)
- Y** Width of crawler track assembly (standard): 31'5" (800mm)  
Width of crawler track assembly (optional): 23'6" (600mm)
- AA** Maximum radius at groundline: 30'6" (9.3)
- AB** Maximum digging depth: 22'0" (6.7)
- AC** Maximum depth for 8' level cut: 20'3" (6.2)
- AD** Minimum radius for 8' level cut at depth "AC": 7'3" (2.2)
- AF** Maximum depth of vertical wall which can be excavated: 4'2" (1.3)
- AG** Minimum level cut radius with bucket flat on groundline: 12'8" (3.9)
- AH** Minimum radius at groundline: 9'0" (2.8)
- AK** Boom pivot to groundline: 5'8" (1.7)
- AL** Boom pivot to axis of rotation: 1'11" (585 mm)
- AP** Bucket tooth radius: 3'10" (1.2)
- AQ** Boom pivot angle: 30° Up and 75° Down
- AS** Bucket pivot angle: 165°
- AU** Maximum telescoping boom length (boom pivot to bucket pivot): 25'3" (7.7)
- AV** Minimum telescoping boom length (boom pivot to bucket pivot): 12'9" (3.9)
- AW** Telescoping boom travel: 12'6" (3.8)
- AX** Bucket tilt angle (both sides of center): 110°
- BA** Maximum radius of working equipment: 31'0" (9.5)
- BB** Maximum height of working equipment: 23'5" (7.1)
- BC** Maximum bucket tooth height: 21'7" (6.6)
- BD** Minimum clearance of bucket teeth with bucket pivot at maximum height: 16'3" (5.0)
- BE** Minimum clearance of fully curled bucket at maximum boom height: 10'5" (3.2)
- BF** Minimum clearance of bucket teeth at maximum boom height: 10'0" (3.0)
- BG** Maximum height of working equipment with bucket below groundline: 14'0" (4.3)
- BH** Radius of bucket teeth at maximum height: 26'4" (8.0)
- BJ** Minimum radius of bucket teeth at maximum bucket pivot height: 19'8" (6.0)

Metric units are meters (m) unless noted.

## Optional Equipment

Work lights: 2 spotlights on boom cradle, 3 floodlights on cab, floodlights on right front shrouding.

Vandalism protection kit including window covers.

Strobe light.

Block heater.

Auxiliary Hydraulics - Inside hose trough with additional hosing and piping for hydraulic powered attachments.

[Maximum pressure 4900 psi (331 BAR)  
Maximum flow 30 GPM (114 L/min)]

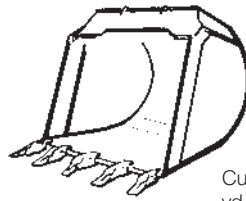

Part No.	Size	Capacity (Cu. yd.)	Capacity (m3)
8045-6020	24" (610mm) Excavating bucket	3/8	.31
8045-6021	30" (762mm) Excavating bucket	1/2	.41
8045-6022	36" (914mm) Excavating bucket	5/8	.54
8045-6023	42" (1.07m) Excavating bucket	3/4	.64
8045-6024	48" (1.22m) Excavating bucket	1	.76

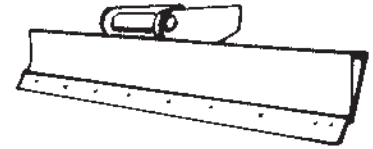

8065-6024 8' (2.4m) Grading blade

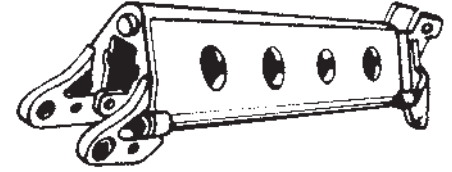

8065-5028 4' (1.2m) Boom extension  
8065-5029 6' (1.8m) Boom extension  
8065-5030 8' (2.4m) Boom extension

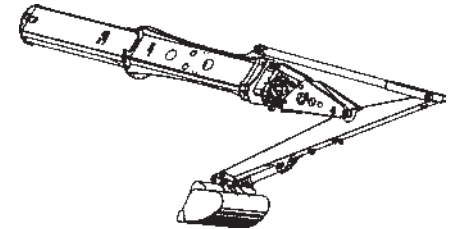

Telestick attachment

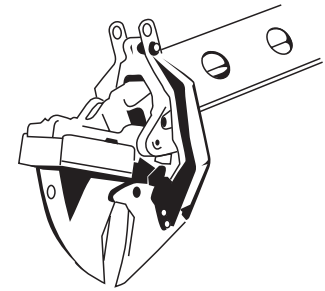

Tree Limb Shear Attachment

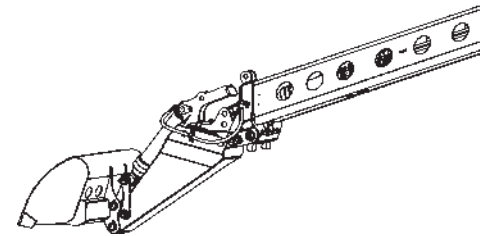

8045-5009 6' (1.8 m) Live Boom

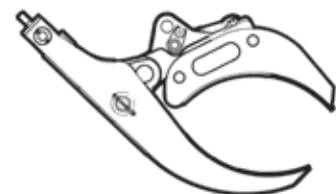

8045-5006 Fixed thumb grapple

## Attachments

Quick change and reversible buckets fabricated of steel plate, with high strength, low alloy cutting edges and wear strips. Standard attachments available for wide range of applications. Capacities shown are in heaped cu. yd.

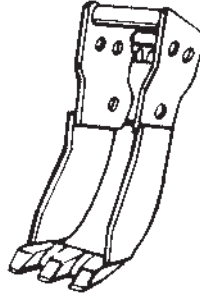

Part No.	Size	Capacity (Cu. yd.)	Capacity (m3)
8065-6104	15" (381mm) Trenching bucket	1/5	.15
8065-6012	21" (533mm) Trenching bucket	1/4	.19

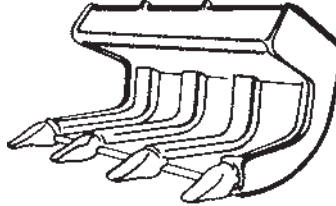

8065-6102	40" (1.02m) Pavement removal bucket
8065-6115	18" (457mm) Pavement removal bucket
8065-6116	24" (610mm) Pavement removal bucket
8065-6114	28" (711mm) Pavement removal bucket

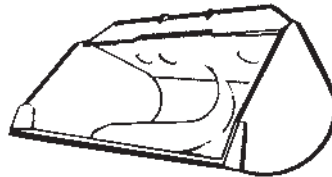

Part No.	Size	Capacity (Cu. yd.)	Capacity (m3)
8065-6040	30" (.762m) Ditching bucket	3/8	.3
8065-6007	60" (1.52m) Ditching bucket	7/8	.73
8065-6006	66" (1.68m) Ditching bucket	1	.76
8065-6002	72" (1.83m) Ditching bucket	1 1/8	.87

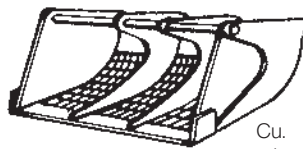

8065-6013	72" (1.83m) Dredging bucket	1 1/8	.87
-----------	-----------------------------	-------	-----

*It is Gradall Policy to continually improve its products. Therefore designs, materials and specifications are subject to change without notice and without incurring any liability on units already sold. Units shown may have optional equipment.*

# GRADALL®

Gradall Industries, Inc.  
406 Mill Ave. SW, New Philadelphia, Ohio 44663  
Phone (330) 339-2211 FAX (330) 339-8468  
www.gradall.com

Certified ISO 9001

